

The Weatherly Bank

A BANK FOR ALL SEASONS

Wood gauge

BASE: .25"
WALLS: .125"

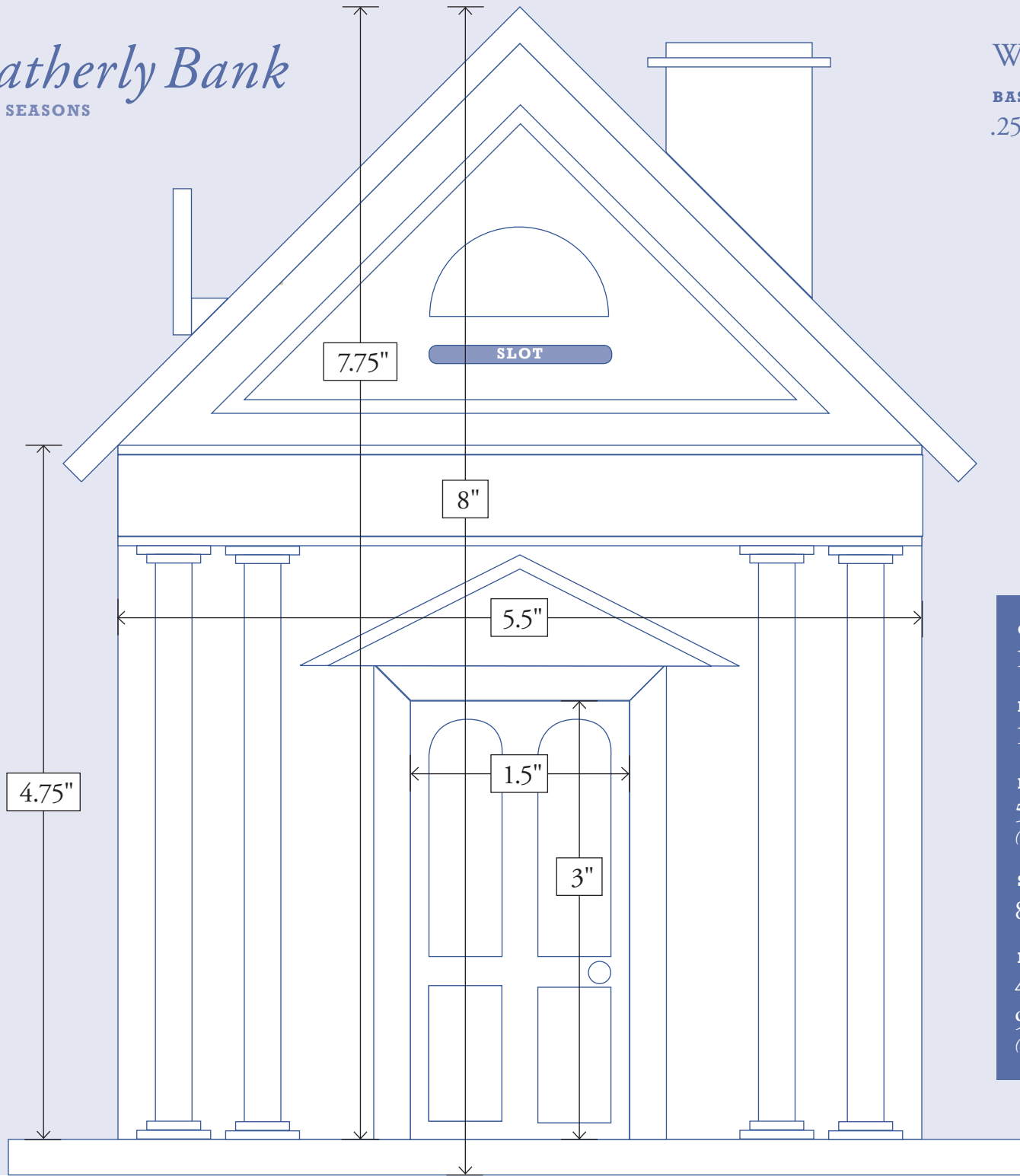

OVERALL SIZE:

10" x 7" x 8"

BASE:

10" x 7"

END WALLS:

5.5" x 7.75"
(minus roof depth)

SIDE WALLS:

8.5" x 4.75"

ROOF:

45° angle

9.5" x 4.25"
(each side)

BANK
FACE

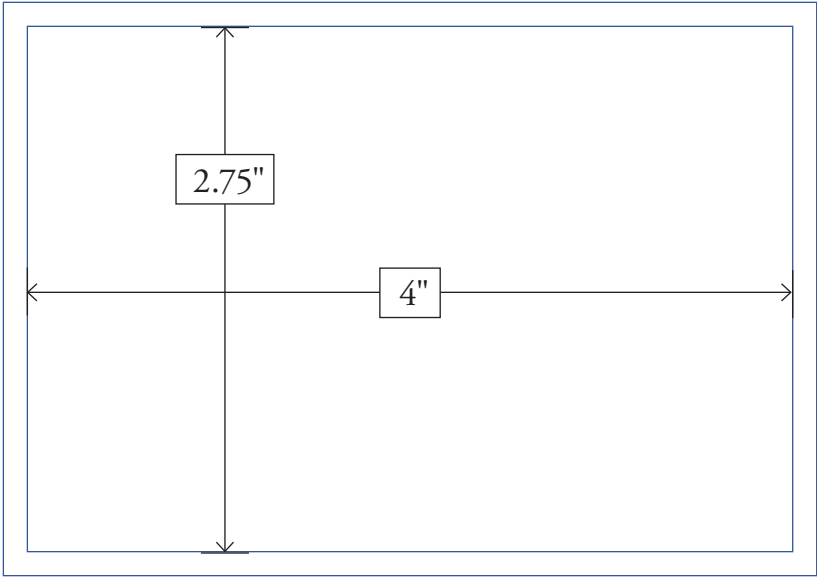
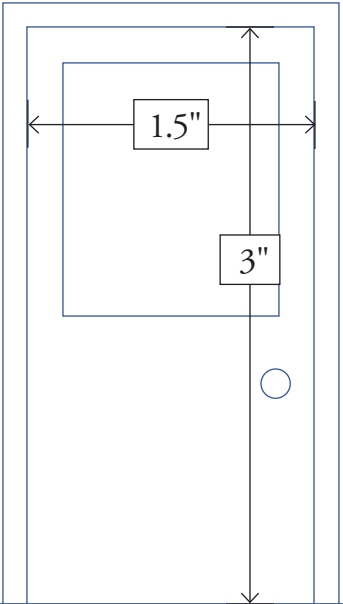
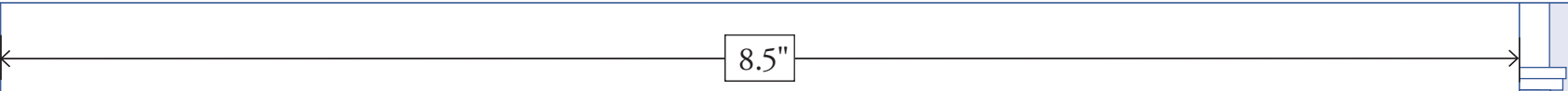
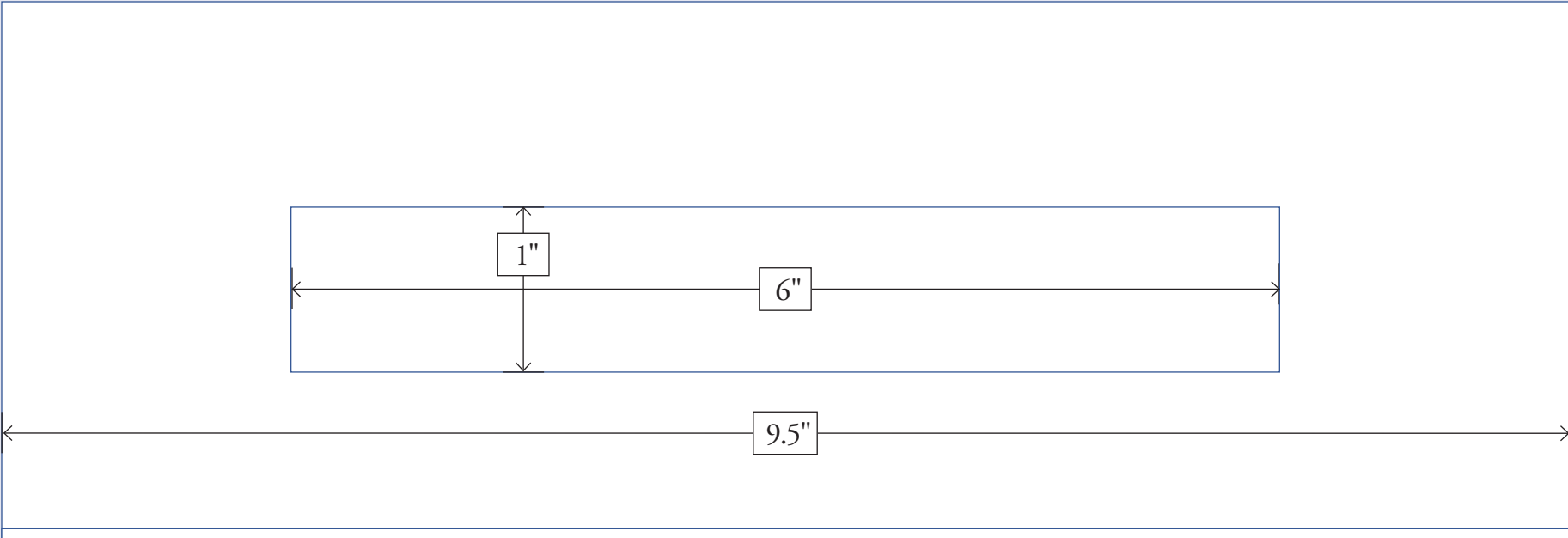

SHOP
FACE

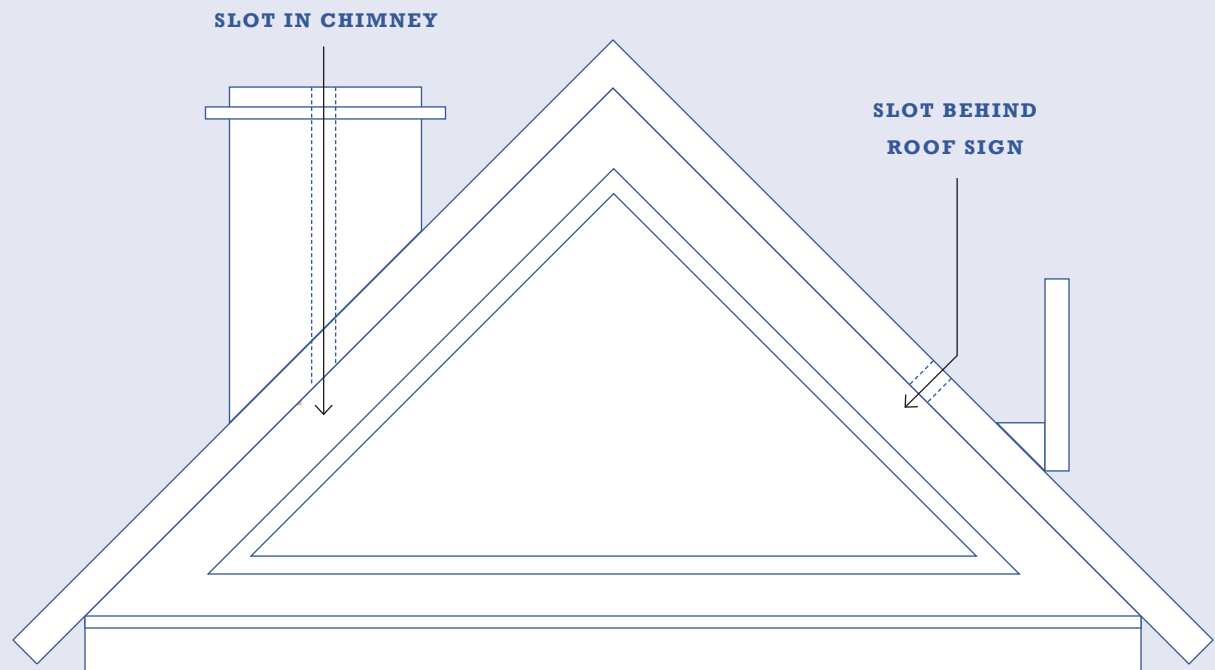

EYELET HOLES FOR ELASTIC BANDS

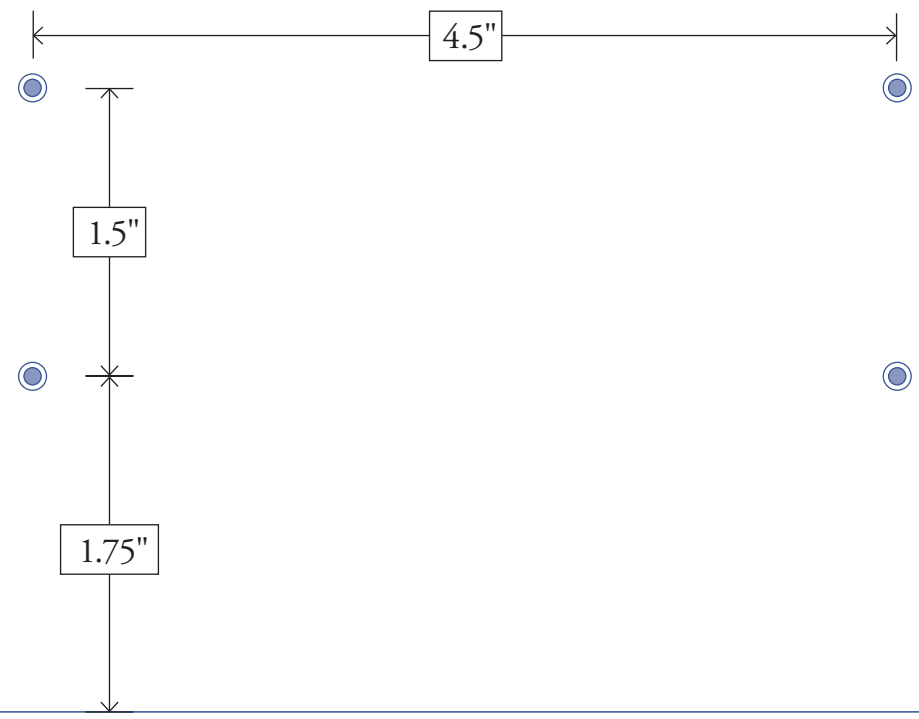

PASSBOOK
FACE

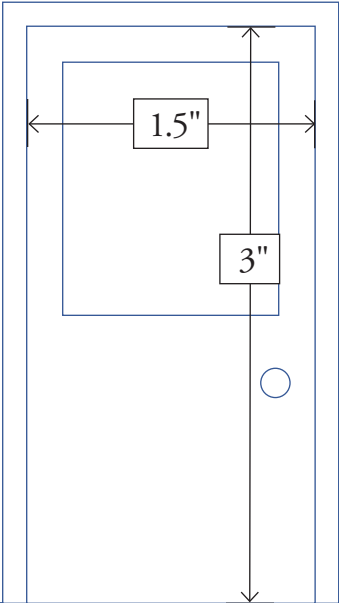
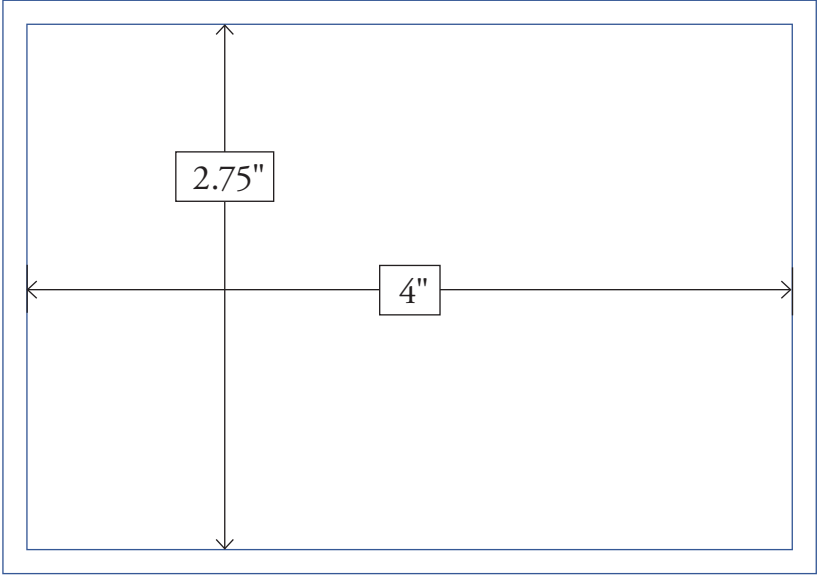
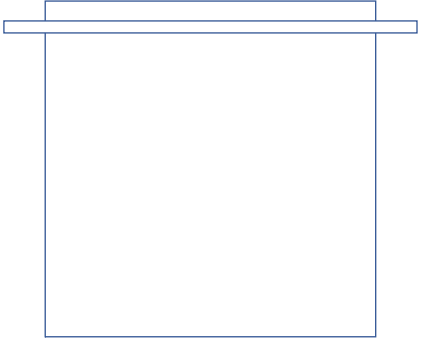
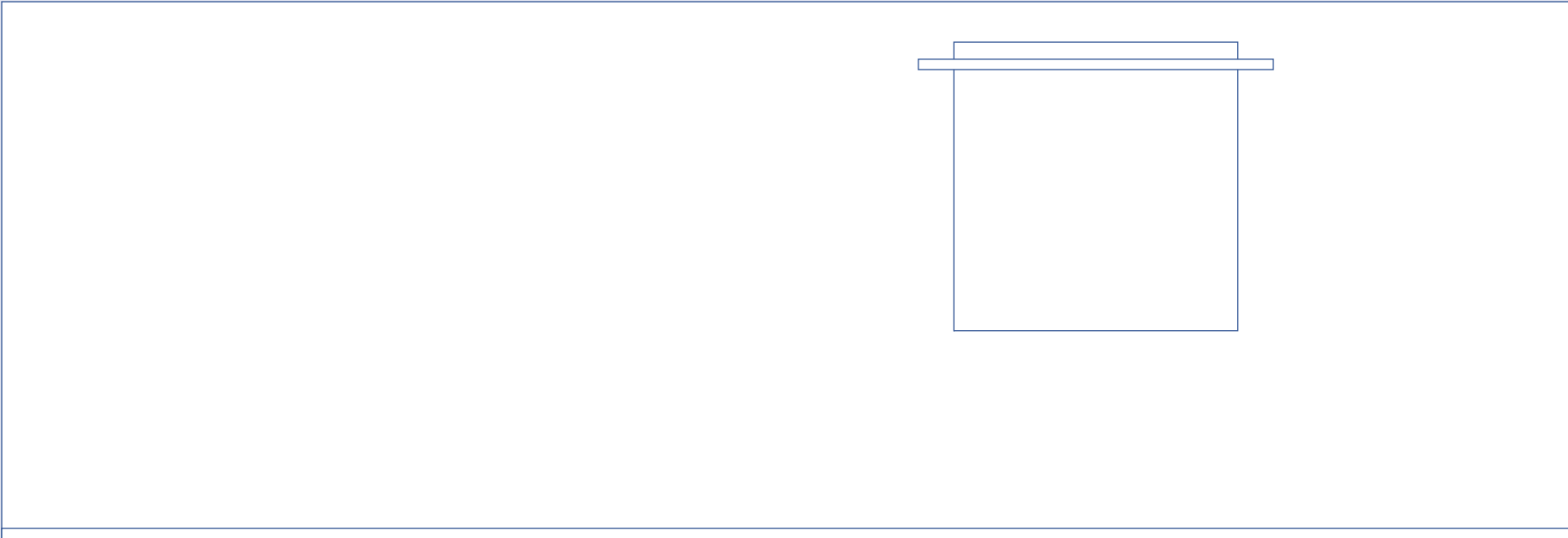

SHOP
FACE

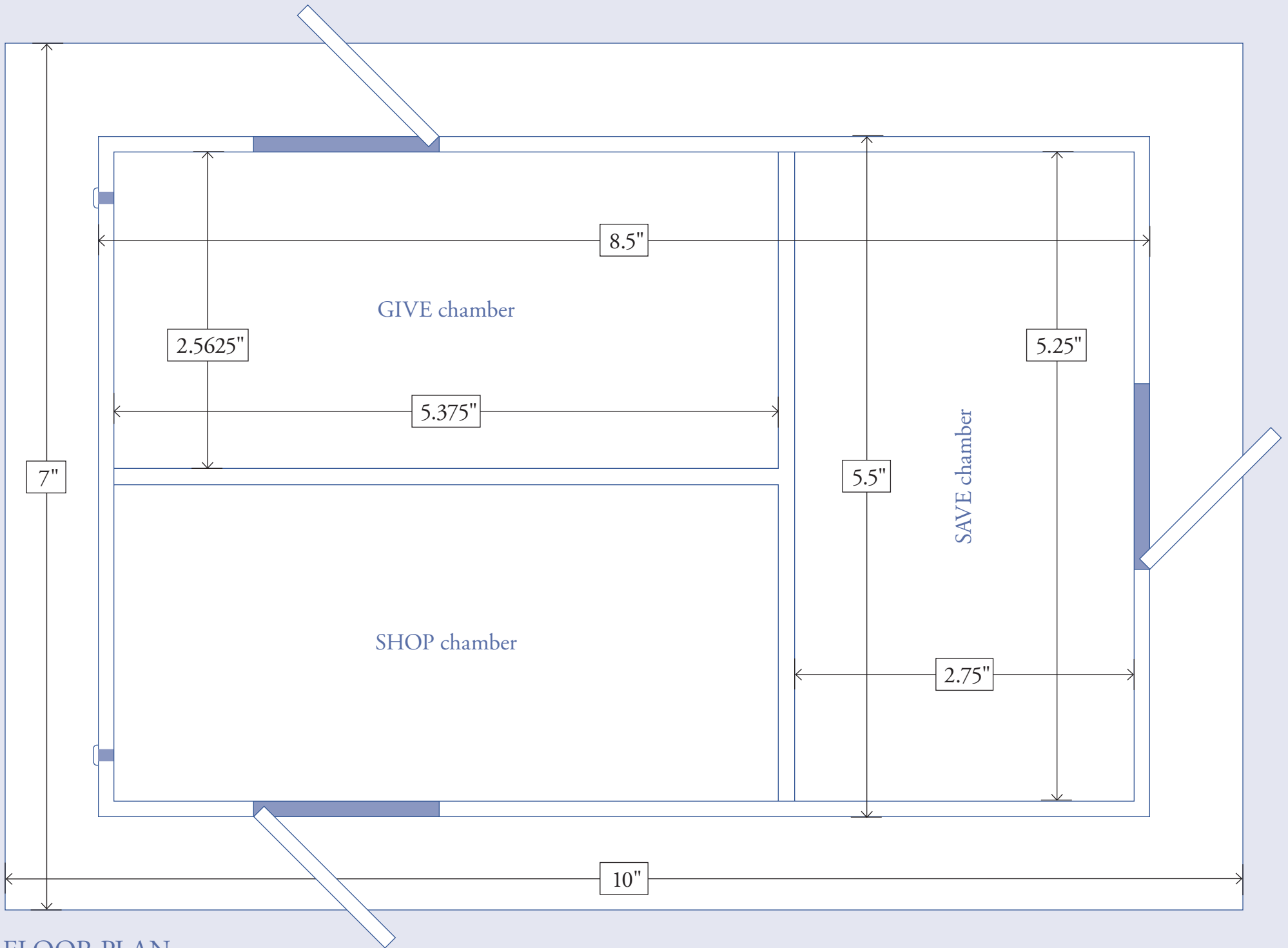

FLOOR PLAN